

Contents

• • •



1998

2004





||

||

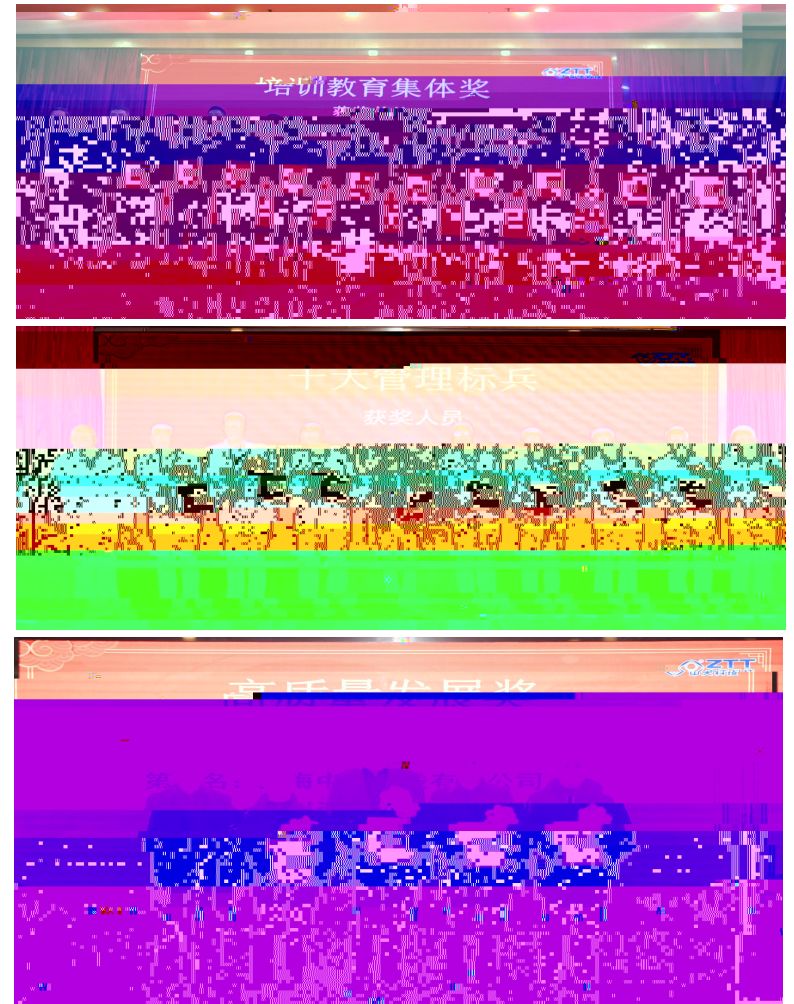



1

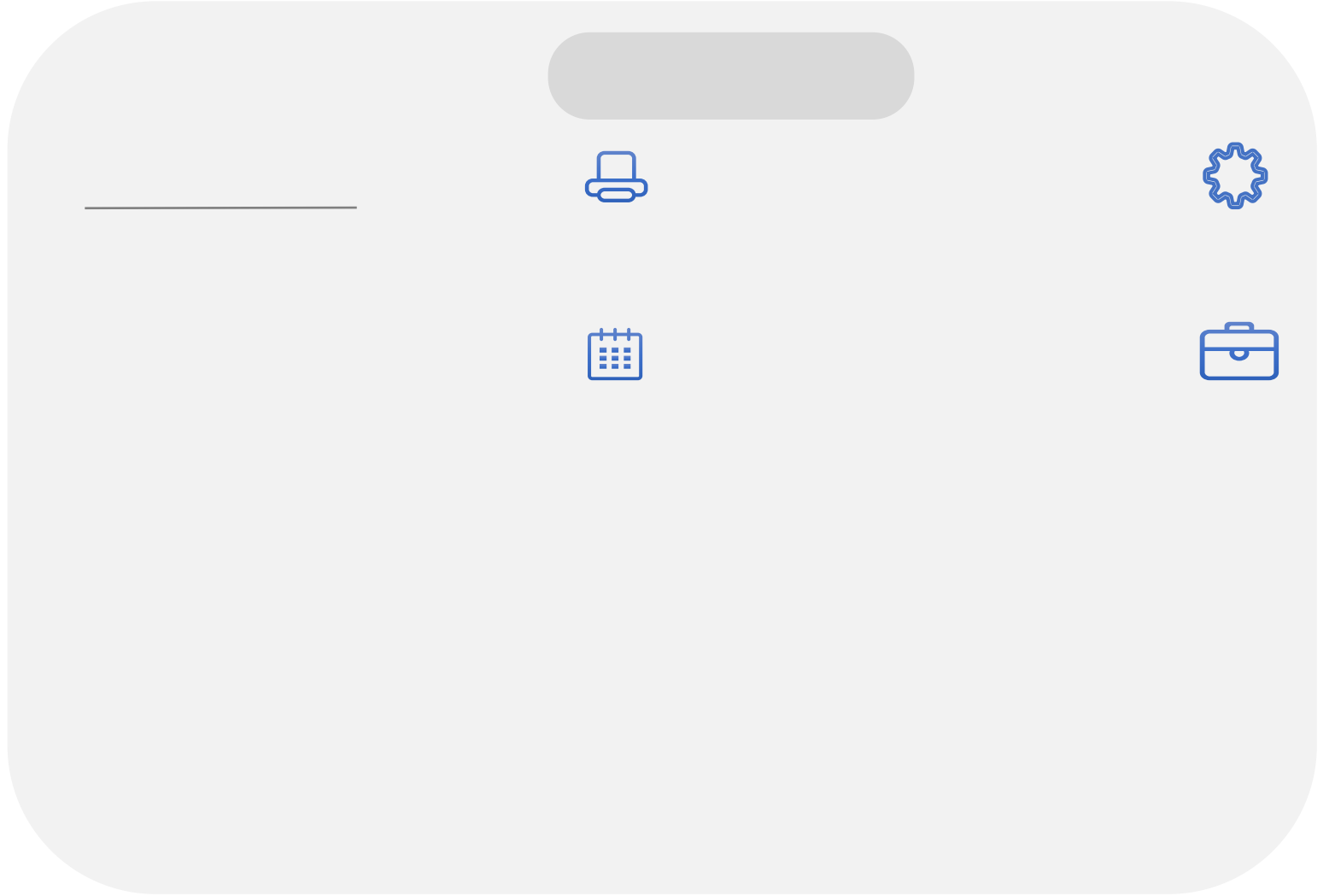
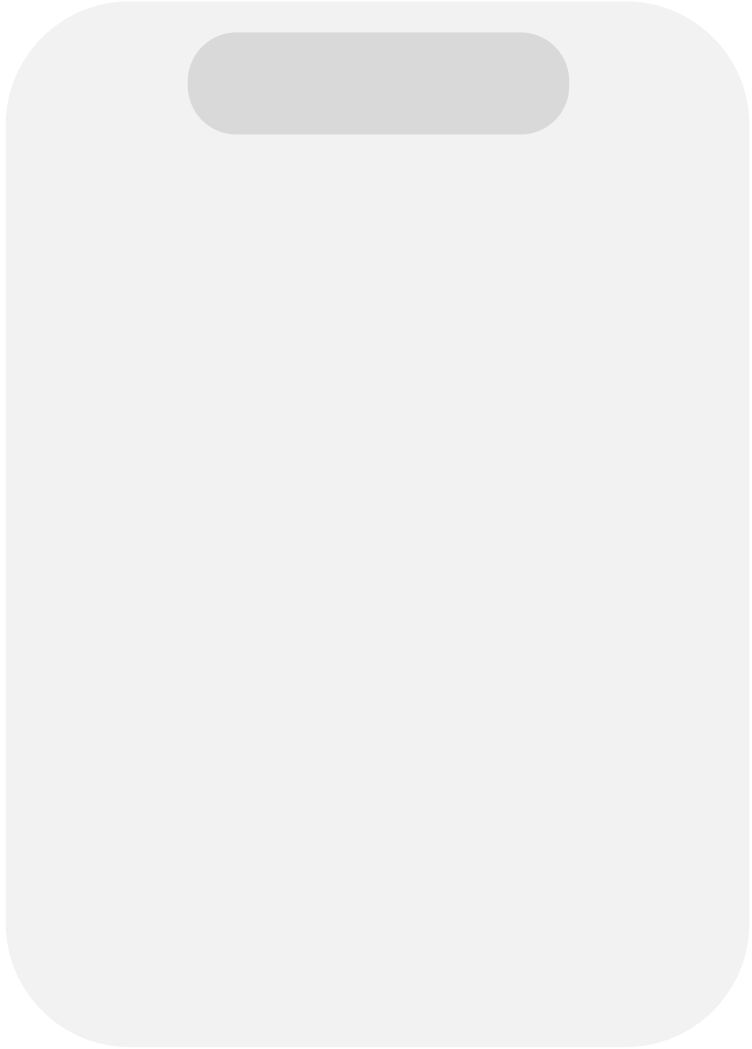



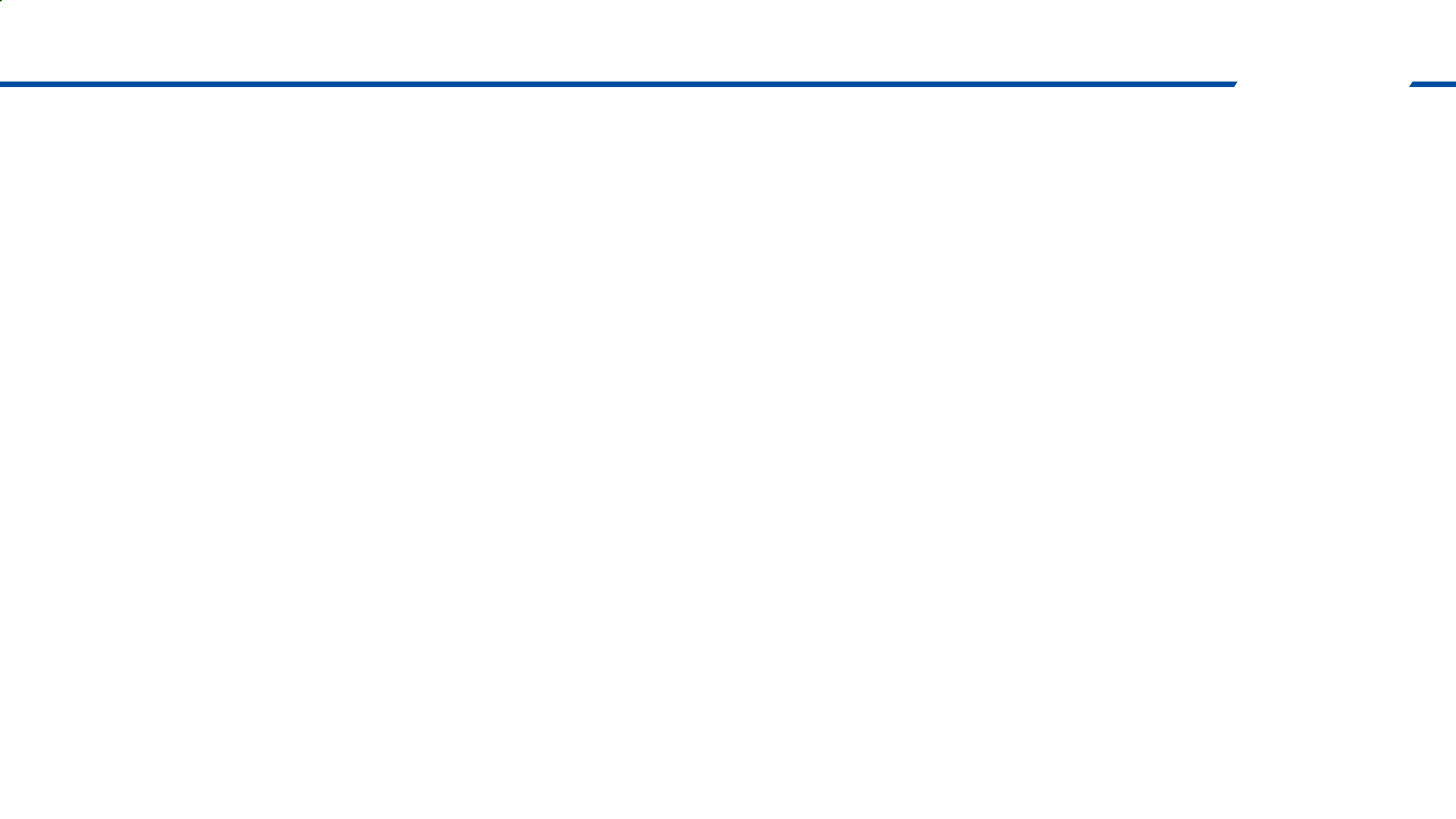



“

”

“

”

原防护罩

改造后

10dB

5

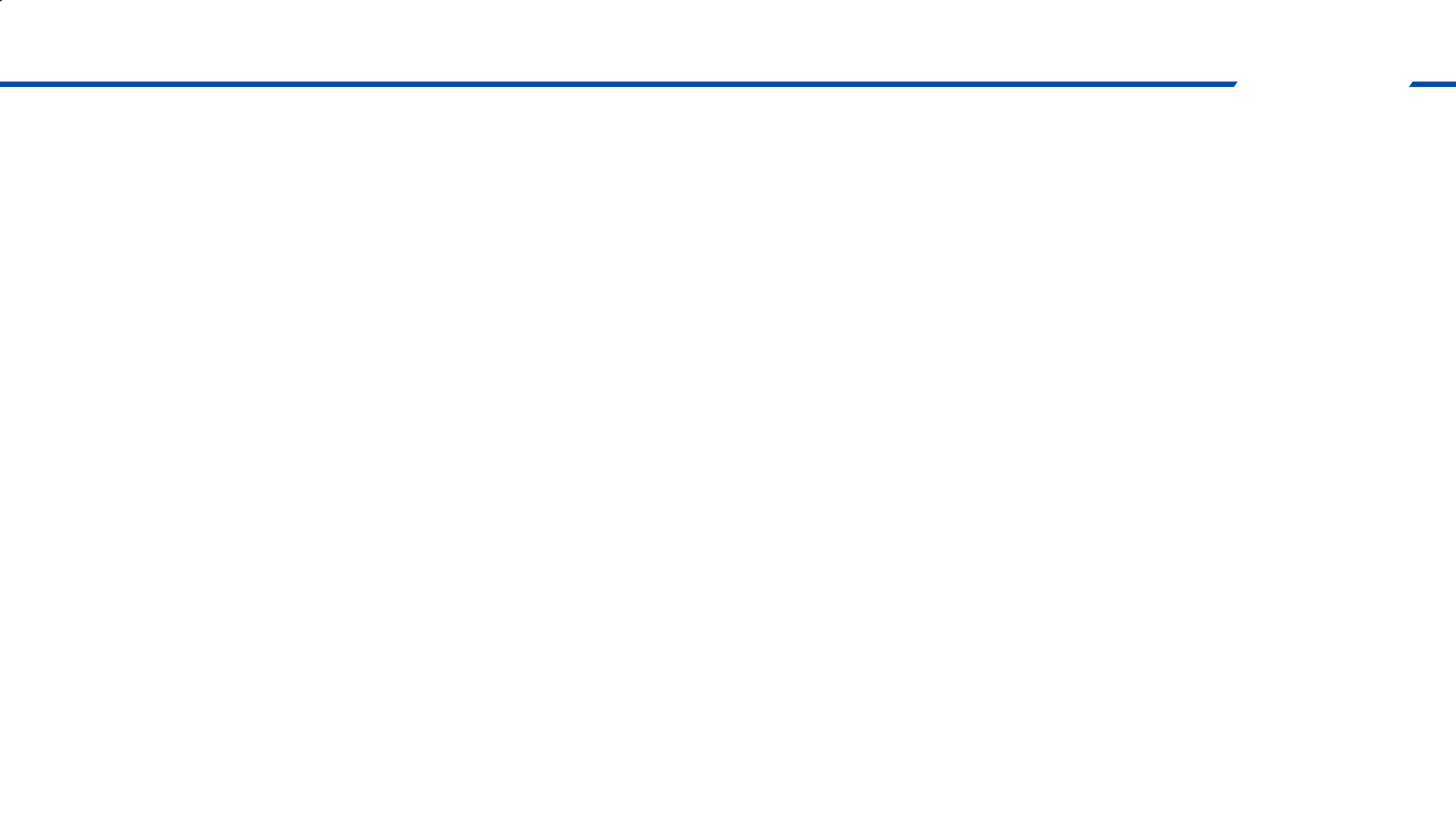



危险废物	
主要成分: 废拉丝油 化学名称: 拉丝油 危险类别: 易燃液体 危险代码: 222 环境代码: 222 危险特性: 易燃性	





4

20%

10%

13

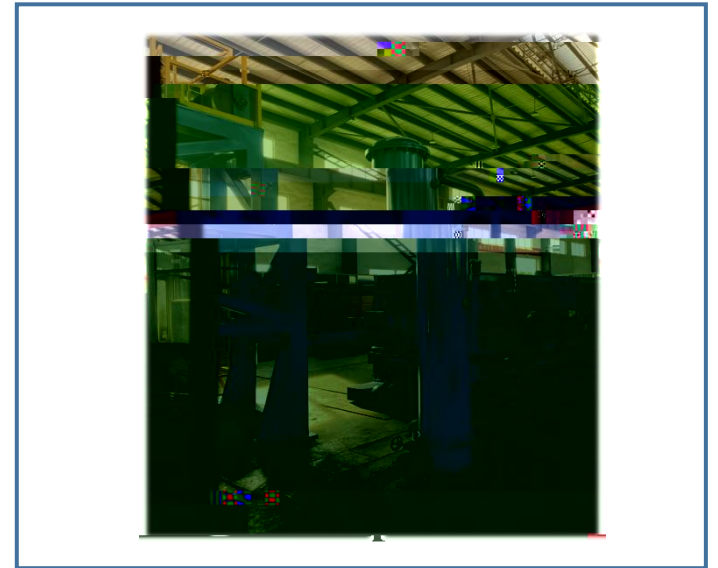
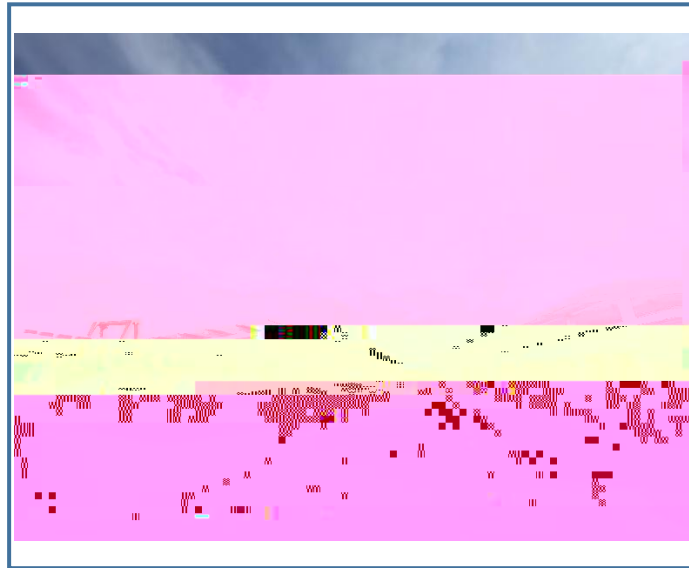
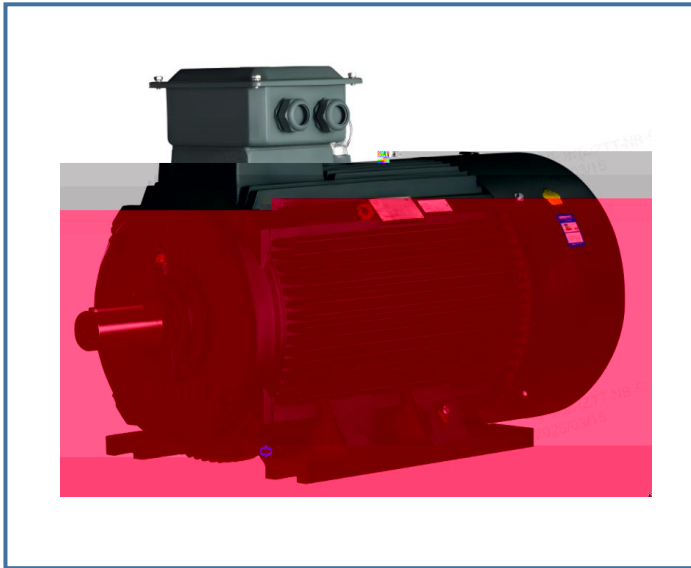



01

02



03

04



"

"

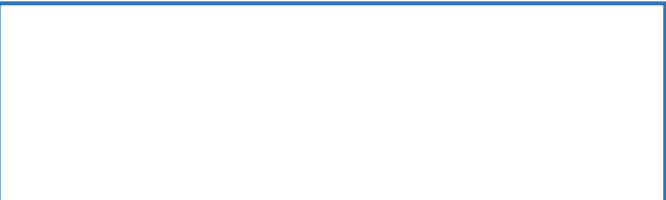

1

				2023	2024	2025			
1		PH		7.4	7.3	7.4	6-9		
2			mg/L	29	26	31	400		
3			mg/L	32	36	34	500		
4			mg/L	6.17	6.36	5.61	45		
5			mg/L	0.97	1.04	0.89	8		
6			mg/L	13.7	14.1	14.5	70		
7			mg/L	0.37	0.38	0.39	20		
8			mg/m	1.35	0.88	1.82	6		
9			dB	57	55.4	58.3	65		/
10			dB	50.1	50.4	49.7	55		/



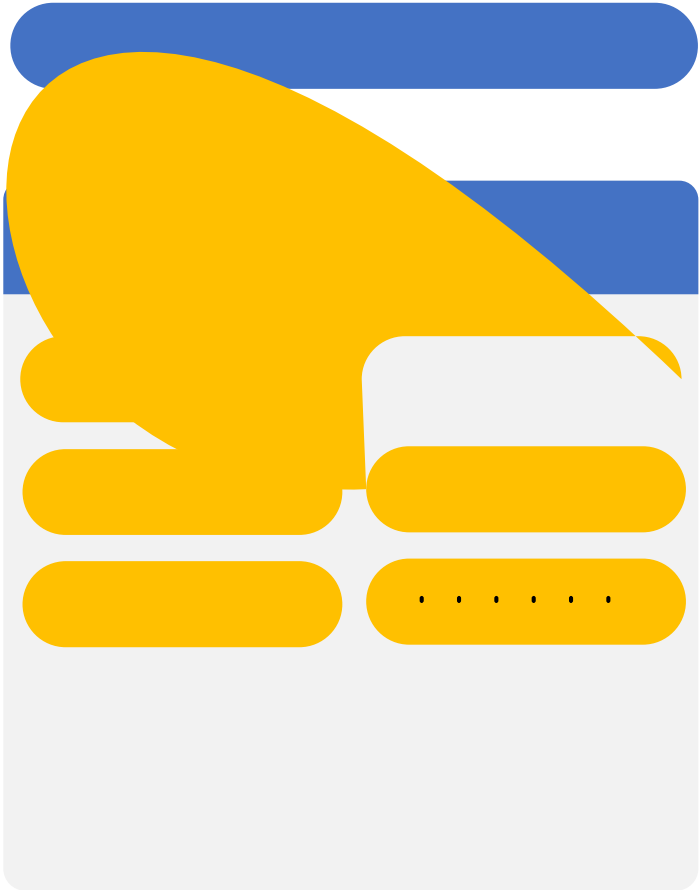

15%

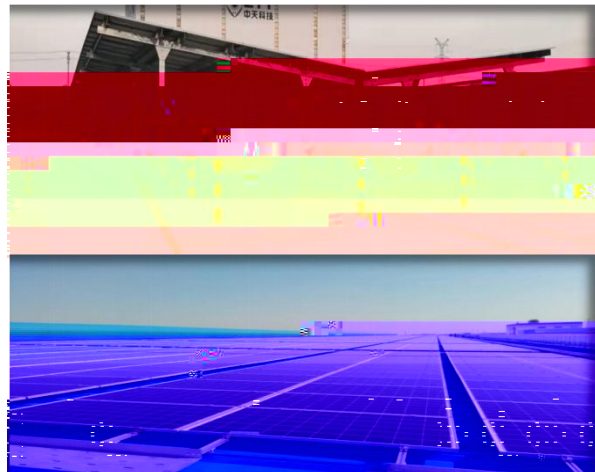
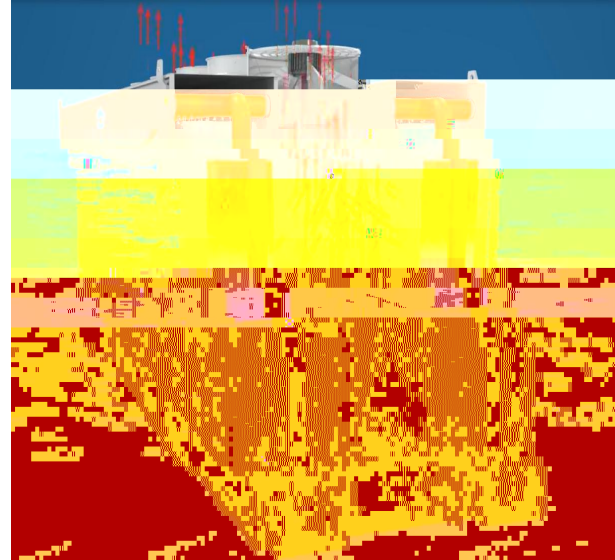

kwh

103.45



SBTI

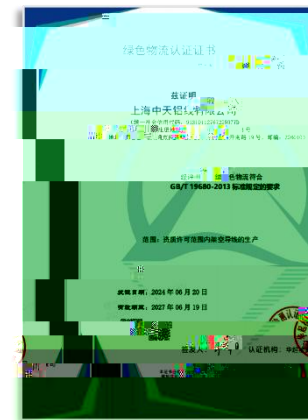
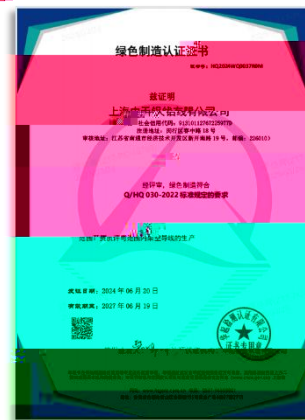
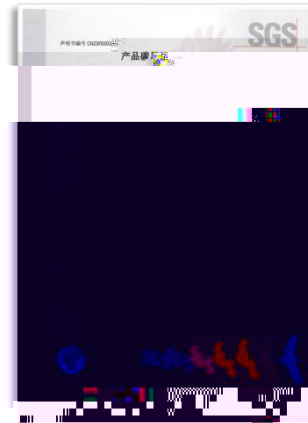

2024		
2994182.23 tCO ₂ e	1	
168.52tCO ₂ e	2	
5049.20 tCO ₂ e	3	
25655.33tCO ₂ e		
	4	
1296128.41tCO ₂ e	5	
1667180.77tCO ₂ e		



谢谢

BYD AUNTY MARK

A LEADING GLOBAL MANUFACTURER
OF CABLE SYSTEMS